

2025
RANGE

Inspired Education

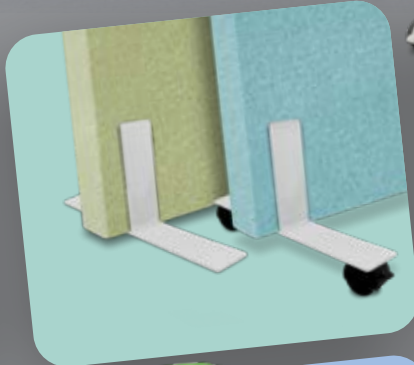
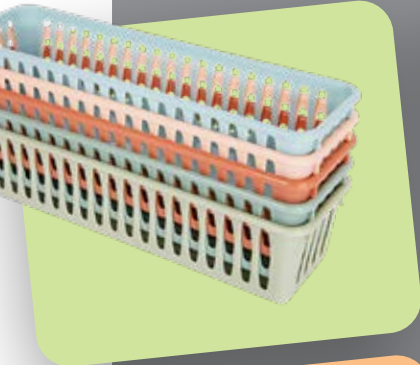

by VISIONCHART

100% Australian Owned Since 1983

At Visionchart, we've been helping Australian schools create inspiring learning spaces for over 40 years. From visual communication tools to flexible classroom furniture, our products support teachers in educating and students in achieving their best.

Imagine • Learn • Create

Explore storage, seating, acoustics and visual communication to help teachers educate and students grow and achieve in their learning.

Here's to learning, growing & achieving...



LUMIÈRE

EDGE

SANA

The logo for GIANT OFFICE FURNITURE is set against a black rectangular background. It features a red square icon with a white diagonal line to the left of the word 'GIANT' in a large, bold, white, sans-serif font. Below 'GIANT' are the words 'OFFICE FURNITURE' in a smaller, bold, white, sans-serif font. At the bottom of the black box, the website address 'www.giantofficefurniture.com.au' is written in a white, sans-serif font.

Contents



4-7

Storage Solutions

NEW

Plastic Storage Tubs
Book Caddies
Book & Magazine Storage Boxes



8-9

Tote Trays & Trolleys

NEW

Oak Tote Tray Trolleys
Metal Frame Tote Trolleys
Colourful Tote Trays



10-13

Seating & Tables

NEW

Sunflower Stools
Cloud Chairs
Student Flexi Desks
Mobile Desk

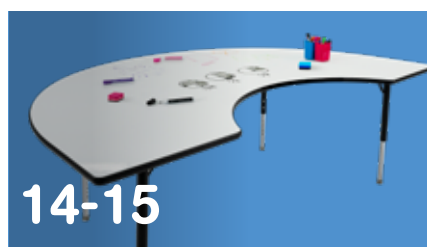

14-15

Whiteboard Tables

NEW

Writable Table Tops
Adjustable Table Legs



16-25

Writing Boards

NEW

Porcelain Whiteboards
Glass & Projection Boards
Mobile & Storage Combo Boards



26-29

Printed Boards

NEW

Term & Year Planners
Music Stave Boards
Custom Coaching Boards



30-33

Wall Acoustics

Peel 'n' Stick Wall Panels
Jigsaw & Hexagon Tiles
Composition Wall Covering

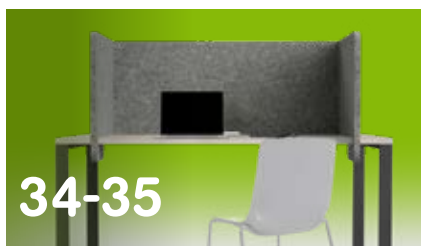

34-35

Desk & Ceiling Acoustic

NEW

Slide-on Desk Screens
Surround Desk Screens
Drop-in Acoustic Ceiling Tiles



36-39

Pinboards

Wrapped Frameless Panels
Velcro® Receptive Mobiles
Wall-mounted Pinboards



40-41

Notice Cases

Hinged & Sliding Door Cases
Snap Frame Signage
Adhesive Sign Holders



42-44

Accessories

Premium Starter Kits
Magnetic Solutions
Whiteboard Cleaning Products



45

Teacher Desk & Lectern

Height Adjustable Desk
Black Steel Lectern



Assembly
Required



Made to
Order



Magnetically
Receptive



Dry wipe
Surface



Pinnable
Surface



Duration of
Surface Warranty



Lock & Key



Weather
Resistant



Velcro®
Receptive

Compact & Colourful *Storage Solutions*

Set Of 4 - Book Caddies
E4CBC



Storage Caddy
ESPC



Connector Tubs
ECT



Elevate classroom organisation effortlessly with small storage tubs and book caddies.

Designed for convenience and functionality, these compact solutions keep educational materials tidy and easily accessible.

Connector Tub



- Size: 85mm (W) x 65mm (D) x 115mm (H)
- Use as a single tub, or connect multiple

ECT-B	Blue
ECT-G	Green
ECT-O	Orange
ECT-P	Purple
ECT-R	Red

ECT-Y	Yellow
ECT-LB	Light Blue
ECT-M	Magenta
ECT-W	White
ECT-LG	Lime Green

Storage Caddy



- Size: 235mm (W) x 227mm (D) x 123mm (H)
- Neatly stacks for space-saving storage when not in use

ESPC-B	Blue
ESPC-G	Green
ESPC-P	Purple
ESPC-LG	Lime Green
ESPC-M	Magenta

ESPC-Y	Yellow
ESPC-R	Red
ESPC-LB	Light Blue
ESPC-O	Orange

Grey Baskets

NEW



- Medium Size: 305mm (W) x 355mm (L) x 135mm (D)
- Large Size: 305mm (W) x 355mm (D) x 220mm (H)
- Designed to hold A4 books, magazines, and essential resources.

ESBK-M	Medium Grey Basket
ESBK-L	Large Grey Basket

NEW

Book Caddies Set Of 4



- Size: 125mm (W) x 315mm (D) x 195mm (H)
- Set of 4: blue, green, red and yellow

E4CBC Book Caddies Set Of 4 Colours

Reading Tub



- Size: 212mm (W) x 212mm (D) x 150mm (H)
- Includes two removable dividers

EPRT-B	Blue	EPRT-P	Purple
EPRT-G	Green	EPRT-R	Red
EPRT-O	Orange	EPRT-Y	Yellow

Large Reading Tub



- Size: 290mm (W) x 300mm (D) x 195mm (H)
- Display A4 sized books forward facing

EPLBT-B	Blue	EPLBT-P	Purple
EPLBT-G	Green	EPLBT-R	Red
EPLBT-O	Orange	EPLBT-Y	Yellow

Book Tub



Optional Caddy Frame

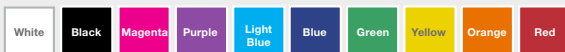

- Size: 145mm (W) x 300mm (D) x 190mm (H)
- Store A4 books and documents
- Optional caddy frame holds up to 5 book tubs (tubs sold separately).

EPBT-B	Blue	EPBT-M	Magenta
EPBT-G	Green	EPBT-BK	Black
EPBT-O	Orange	EPBT-W	White
EPBT-P	Purple	EPBT-GND	Ground
EPBT-R	Red	EPBT-GRS	Grass
EPBT-Y	Yellow	EPBT-SKY	Sky
EPBT-LB	Light Blue	EBTDCS	Caddy Frame

Pencil Storage Baskets



- Pack of 10 pencil storage baskets
- 2 each of Light Olive Green, Mint Green, Burnt Orange, Peach and Light Blue
- Size: 254mm (L) x 83mm (W) x 64mm (H) (each basket)

EPBP10	Pencil Storage Basket Pack of 10	NEW
---------------	----------------------------------	------------

Book Boxes, Story Boxes & Magazine Storage

- Colour organisation
- Available in packs of 5, with a choice of up to 13 individual colours or a mix of 5 (red, blue, green, yellow, purple).
- Easy fold-to-assemble cardboard boxes

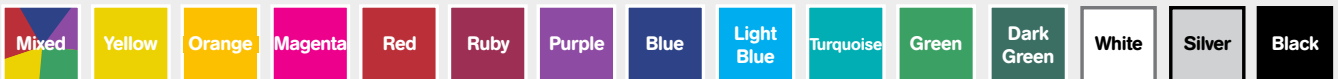

Magazine Box



- Size: 245mm (L) x 90mm (W) x 280mm (H)

Magazine Box - Pack Of 5

E5MB	Mix Pk 5 - Red, Yellow, Green, Blue, Purple
E5MB-R	Magazine Box - Red
E5MB-Y	Magazine Box - Yellow
E5MB-LB	Magazine Box - Light Blue
E5MB-G	Magazine Box - Green
E5MB-P	Magazine Box - Purple
E5MB-M	Magazine Box - Magenta
E5MB-O	Magazine Box - Orange
E5MB-B	Magazine Box - Blue
E5MB-DG	Magazine Box - Dark Green
E5MB-RY	Magazine Box - Ruby
E5MB-S	Magazine Box - Silver
E5MB-T	Magazine Box - Turquoise
E5MB-BK	Magazine Box - Black
E5MB-W	Magazine Box - White

Story Book Box



- Size: 220mm (L) x 165mm (W) x 155mm (H)

Story Book Box - Pack Of 5

E5SB	Mix Pk 5 - Red, Yellow, Green, Blue, Purple
E5SB-R	Story Book - Red
E5SB-Y	Story Book - Yellow
E5SB-LB	Story Book - Light Blue
E5SB-G	Story Book - Green
E5SB-P	Story Book - Purple
E5SB-M	Story Book - Magenta
E5SB-O	Story Book - Orange
E5SB-B	Story Book - Blue
E5SB-T	Story Book - Turquoise
E5SB-BK	Story Book - Black
E5SB-W	Story Book - White

Book Box



- Size: 250mm (L) x 170mm (W) x 280mm (H)

Book Box - Pack Of 5

E5BB	Mix Pk 5 - Red, Yellow, Green, Blue, Purple
E5BB-R	Book Box - Red
E5BB-Y	Book Box - Yellow
E5BB-LB	Book Box - Light Blue
E5BB-G	Book Box - Green
E5BB-P	Book Box - Purple
E5BB-M	Book Box - Magenta
E5BB-O	Book Box - Orange
E5BB-B	Book Box - Blue
E5BB-T	Book Box - Turquoise
E5BB-BK	Book Box - Black
E5BB-W	Book Box - White

Get Tote-ally Organised

Tote Trays and Trolleys



Tote Trays

- Use with our range of tote trolleys for an ultimate storage unit
- Tray Size: 430mm (L) x 320mm (W) x 125mm (H)
- Clear lid ETTLD (sold separately) clicks firmly into position to keep resources secure
- Store small resources with 28-section insert ELST (sold separately)

ETT-B	Blue Tote Tray
ETT-G	Green Tote Tray
ETT-O	Orange Tote Tray
ETT-P	Purple Tote Tray
ETT-R	Red Tote Tray
ETT-Y	Yellow Tote Tray
ETT-W	White Tote Tray
ETT-LB	Light Blue Tote Tray
ETT-BK	Black Tote Tray
ETT-M	Magenta Tote Tray
ETT-C	Clear Tote Tray
ETT-GND	Ground Tote Tray
ETT-GRS	Grass Tote Tray
ETT-SKY	Sky Tote Tray

Tote Tray Extras

ELST	Storage Insert
ETTLD	Tote Tray Clear Lid

NEW
NEW
NEW



NEW

Metal Slide In Bays Tote Tray Trolleys

- Our tote tray trolleys are perfect to use with our tote trays (ETT)
- Constructed metal frame and mounted on lockable castors
- Add our tote tray colours to create a stimulating learning space



5 Bays

10 Bays

15 Bays



EMTTS	Single - 5 Bays Trolley	Size: 380mm x 440mm x 920mm
EMTTD	Double - 10 Bays Trolley	Size: 740mm x 440mm x 920mm
EMTTT	Triple - 15 Bay Trolley	Size: 1100mm x 440mm x 920mm



Oak Finish Bays Tote Tray Trolleys

- Our tote tray trolleys are perfect to use with our tote trays (ETT)
- Constructed from MDF and mounted on lockable castors



12 Bays

16 Bays



EMTT12	Oak - 12 Bay Trolley	Size: 1180mm x 450mm x 860mm
EMTT16	Oak - 16 Bay Trolley	Size: 1440mm x 450mm x 860mm



Tote trays sold separately.

Flexible Seating Solutions for Active Learners



Sunflower Stool Range
EBS



Sunflower Stools

- Available in 4 colours: lake green, dark red, ocean blue and orange
- Widths/Depths: 350mm
- Heights:
 - Kindergarten: 310mm
 - Lower Primary: 370mm
 - Upper Primary: 450mm
 - High School/Adult: 520mm
- Light and easy to move, perfect for school use and easy to clean
- Easy wipe clean



EBS31-B	Ocean Blue	310mm (H)
EBS31-G	Lake Green	310mm (H)
EBS31-O	Orange	310mm (H)
EBS31-R	Dark Red	310mm (H)

EBS37-B	Ocean Blue	370mm (H)
EBS37-G	Lake Green	370mm (H)
EBS37-O	Orange	370mm (H)
EBS37-R	Dark Red	370mm (H)

EBS45-B	Ocean Blue	450mm (H)
EBS45-G	Lake Green	450mm (H)
EBS45-O	Orange	450mm (H)
EBS45-R	Dark Red	450mm (H)

EBS52-B	Ocean Blue	520mm (H)
EBS52-G	Lake Green	520mm (H)
EBS52-O	Orange	520mm (H)
EBS52-R	Dark Red	520mm (H)

Ezi Sit Student Chair



- Light Blue
- Lime Green
- Red

- Size: 550mm (W) x 450mm (H) (when the backrest is utilised)
- Weight limit is 70kgs
- Comfortable and soft, simply fold flat to store

ESFC-B	Blue
ESFC-G	Lime Green
ESFC-R	Red

Cloud Chair

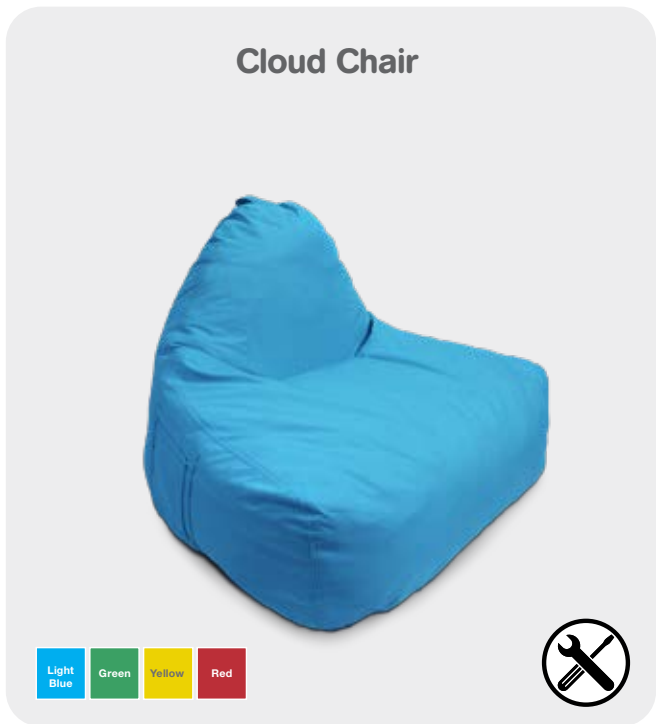

- Light Blue
- Green
- Yellow
- Red



- Small: 800mm x 800mm x 720mm, Medium: 970mm x 910mm x 780mm
- 4 Colours: green, red, blue and yellow
- Comfortable compressed foam cloud chairs
- UV protected coated polyester, water repellent

ECOCS-B	Small - Blue	ECOCM-B	Medium - Blue
ECOCS-G	Small - Green	ECOCM-G	Medium - Green
ECOCS-R	Small - Red	ECOCM-R	Medium - Red
ECOCS-Y	Small - Yellow	ECOCM-Y	Medium - Yellow

Dipper Chair

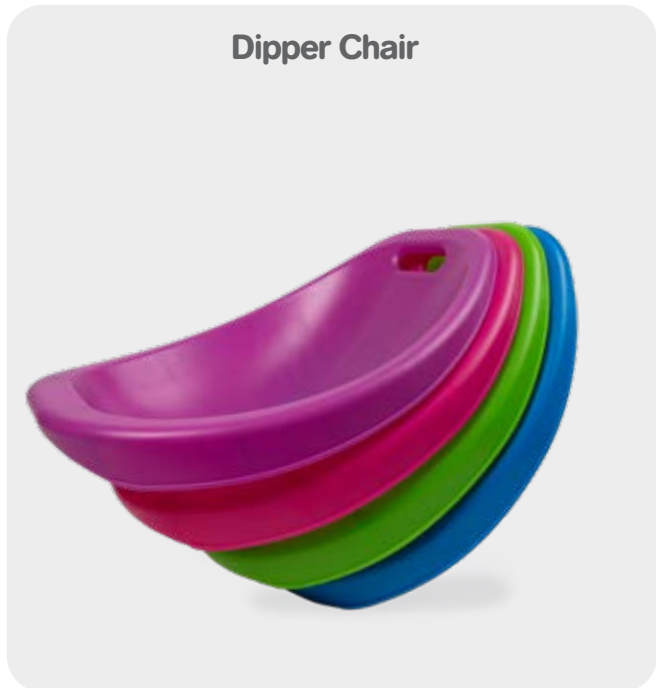

- Size: 360mm–390mm (L) x 450mm (W)
- Set of 4: light blue, purple, green and magenta
- Allows movement and comfort

E4PSR	Dipper Set 4
--------------	--------------

On Your Marks

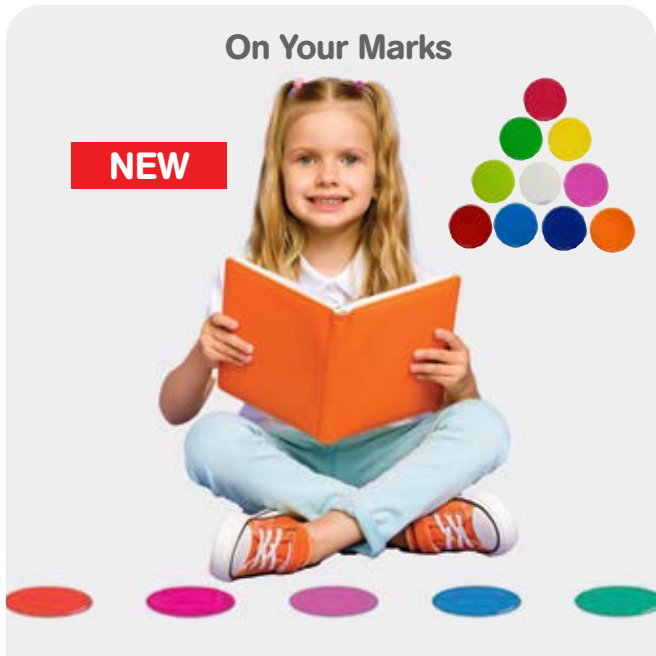

- Hook-and-loop backing - easy to reposition and remove – leaves no residue
- Durable and vibrant design – withstands regular classroom use
- Define seating or standing positions for seating arrangements, games, and group tasks

EOYM10	100mm Assorted Colours Pack of 10	NEW
EOYM14	140mm Assorted Colours Pack of 10	

Group Time Table



- Size: 1200mm (W) x 280mm (H)
- Students can access a generous workspace while seated on the floor
- Manufactured from MDF which meets Australian standards
- Finished with a woodgrain laminate for a durable, easy to clean surface

ECCT

MDF Laminate Group Time Table

Dry Erase Folding Lap Desk



- Legs fold flat for easy storage
- Whiteboard surface is dry erase compatible
- Desktop Size: 600mm (L) x 400mm (W)
- Desk Height (when in use): 290mm from the ground
- Top made from MDF and laminate for easy cleaning

EFLP

Dry Erase Folding Lap Desk

NEW

Student Flexi Desk



- Size: 580mm (W) x 300mm (D) x 200mm (H)
- Sold as a set of 4 in one colour – red, dark blue, or lime green
- Sold as a set of 4 in a mix of four colours – pastel or bright options
- 3 Storage compartments per desk

E4SLDMP-B	Dark Blue
E4SLDMP-L	Lime Green
E4SLDMP-R	Red
E4SLDMP-ASP	Pastel Bundle
E4SLDMP-ASB	Bright Bundle

Z Flexi Desk

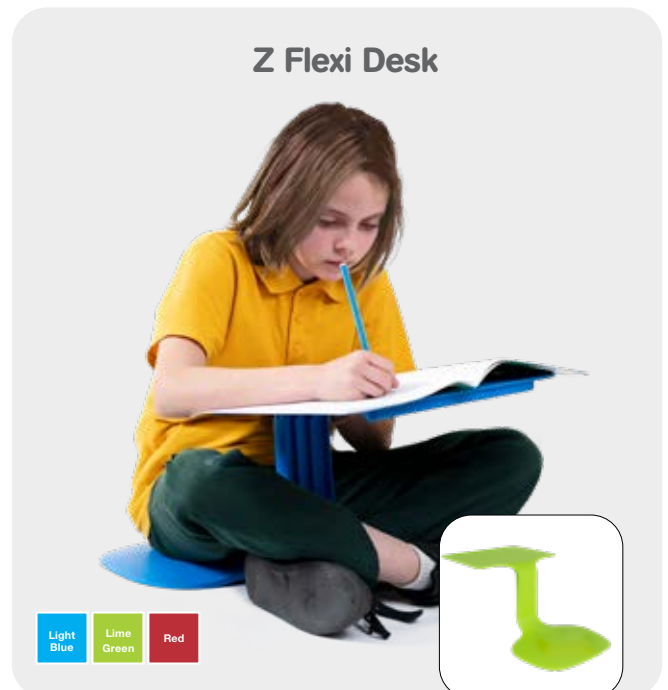

- Sturdy, high-quality plastic making it durable and easy to clean
- Stackable for quick and convenient storage when not in use

EFLEX-B	Blue
EFLEX-R	Red
EFLEX-L	Lime Green



Tactile Cushions

Improves posture and focus

- Small 330mm round blue cushion, includes a hand pump
- Large 600mm round grey cushion, includes a hand pump
- Spiky texture improves posture and focus
- Includes pump for inflation

ETC
ETC-L

Blue Small Tactile Cushion
Grey Large Tactile Cushion

NEW

NEW



Height Adjustable Mobile Desk

- Height adjustable: 760mm (seated) to 1110mm (standing) via side lever
- Adjustable desk angle: Flat, tilted, or fully vertical for stackable storage
- 2 lockable wheels: Easy to move and secure
- Durable: Holds up to 8kg, built to last
- Space-saving: Compact design with ample 520 x 700mm top workspace
- Multi-purpose: Laptop desk, projector stand, lectern, or mobile workspace
- Easy setup: Simple assembly with instructions

BRL101 Height Adjustable Lectern / Desk

NEW

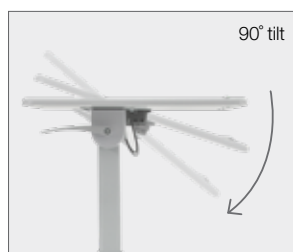

YouTube



Whiteboard Tables

Just add matching legs



Make Learning Interactive, Collaborative & Fun

Bring lessons to life with Creative Kids Dry Erase Tables—designed to spark creativity, teamwork, and hands-on learning in any classroom. Whether it's brainstorming, solving maths problems, or sketching ideas, students can write, draw, and collaborate directly on the table surface. With a quick wipe, they're ready for the next big idea.

Why Choose Creative Kids Dry Erase Tables?

- Writable, Wipeable Surfaces – Encourages active learning and makes cleaning up after lessons a breeze.
- Flexible Shapes & Sizes – Available in Jellybean, Double, Single, Trapezoid, and Smart shapes to suit any teaching style.
- Adjustable Height Legs – Match tables to students from early years to high school with easy fit legs (sold separately).
- Create Your Ideal Classroom Layout – From single workstations to collaborative clusters, these tables adapt to your space.

Endless Configurations

Adapt classroom layouts for changing needs



Jellybean Writable Table Top Only



- Writable dry erase top only - size: 1800mm (W) x 1180mm (D)
- Spacious, collaborative design for group learning.

ECCJB-TOP

Jellybean Top Only

NEW

Double Writable Table Top Only



- Writable dry erase top only - size: 1200mm (W) x 1180mm (D)
- Perfect for paired activities and teamwork.

EDED-TOP

Double Table Top Only

NEW

Single Writable Table Top Only



- Writable dry erase top only - size: 600mm (W) x 600mm (D)
- Ideal for focused, individual workspaces

EDEST-TOP

Single Table Top Only

NEW

Trapezoid Writable Top Only

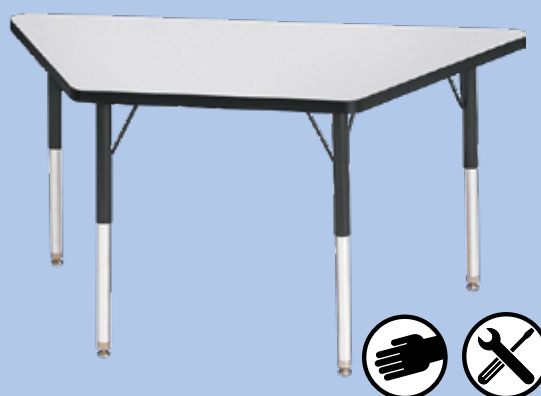

- Writable dry erase top only - size: 1200mm (W) x 520mm (D)
- Flexible layouts for dynamic group settings.

EDETD-TOP

Trapezoid Table Top Only

NEW

Smart Writable Table Top Only



- Writable dry erase top only - size: 1200mm (W) x 600mm (D)
- Sleek, curved design for modern classrooms

EDEHMT-TOP

Smart Table Top Only

NEW

Set of 4 Legs to Match Tops



- Height adjustable: 500mm – 750mm
- Supports a variety of learning styles and ages

ETB-LEG

Set of 4 Legs to Match Tops

NEW

Classroom Whiteboards

Tough and tested solutions



Porcelain Whiteboards

Porcelain surface (or vitreous enamel) whiteboards are ideal for heavy duty use such as schools, higher education and conference centres.

- Hard-wearing magnetic porcelain surface
- 25 year surface warranty
- Full length aluminium pen tray
- Standard aluminium frame
- Concealed wall fittings

PB9060	900 x 600mm
PB9090	900 x 900mm
PB1290	1200 x 900mm
PB1212	1200 x 1200mm
PB1590	1500 x 900mm
PB1512	1500 x 1200mm
PB1890	1800 x 900mm
PB1812	1800 x 1200mm
PB2112	2100 x 1200mm
PB2412	2400 x 1200mm
PB3012	3000 x 1200mm
PB3612	3600 x 1200mm

4 Colourful magnets and an Aluminium pen tray included



25 Year

LX8 Edge Projection Porcelain Whiteboards

A whiteboard and projection screen in one.
60% less glare reflection than our standard porcelain whiteboards.

- Slim, sleek EDGE frame with minimal 4mm lip
- Unique flat-to-wall mounting system
- PolyVision e3™ Projection Porcelain whiteboard suitable for use with interactive and passive short throw projectors.
- 25 year surface warranty
- Sizes up to 3000 x 1200mm



The only whiteboard fire-tested Group 1 compliant to Australian Standards 1530.3

LX8-1512-P	1500 x 1200mm
LX8-1812-P	1800 x 1200mm
LX8-2012-P	2000 x 1200mm
LX8-2412-P	2400 x 1200mm
LX8-3012-P	3000 x 1200mm



Lumiere Glass Whiteboards

- Contemporary – alternative to traditional whiteboards highlighted by the translucency and elegance of premium glass
- Quality – toughened safety glass, non-porous surface will not ghost or stain and works with standard dry-erase markers
- Frameless – tempered glass is borderless to create clean lines, uncluttered and ultra modern appearance
- STARPHIRE GLASS - is completely clear as most of the iron oxides have been removed - helps eliminate colour distortion



Classroom Safe

VGB9060	900 x 600mm
VGB1290	1200 x 900mm
VGB1212	1200 x 1200mm
VGB1590	1500 x 900mm

VGB1512	1500 x 1200mm
VGB1812	1800 x 1200mm
VGB2112	2100 x 1200mm
VGB2412	2400 x 1200mm

Lumiere BLACK	
VGB1260-B	1200 x 600mm
VGB1812-B	1800 x 1200mm

Stylish Fixtures



IdeaBoard™ A-Frame

NEW

Double Writing & Storage



IdeaBoard™ A-Frame Mobile Double Sided Whiteboard

IdeaBoard™ - the multi-functional storage mobile whiteboard. Featuring an A-frame design in a wood finish. Offering two large writing surfaces and a magnetically receptive acoustic pinboard base. Store away tools and accessories in the side drawers and storage cubby holes.

- Double-sided magnetic whiteboard surface
- Overall Size: 1000mm (W) x 1820mm (H) x 700mm (D)
- Acoustic Panel Pinboards (x2): 940mm (W) x 335mm (H) x 18mm (D)
- Built-in storage drawers and cubby holes
- Includes 2 metal flipchart hooks
- Magnetically attached (removable) acoustic panel pinboards
- 6 castor wheels for ultimate mobility
- 5 year whiteboard surface warranty



Storage cubby and draw on each side



Magnetically attached acoustic pinboard, reposition to wherever needed.



6 heavy duty locking castors allow it to easily be moved



2 flipchart hooks included

IDB1810

IdeaBoard™ Mobile A-Frame

NEW

Read, Write & Store Centre

- Premium Quality Porcelain Magnetic Whiteboard: 800mm x 900mm
- 100mm-deep, no-lip shelf designed for displaying books.
- Constructed from structural MDF with white oak wood laminate
- Heavy duty castor wheels for easy mobility
- Two large (one lockable) drawers for holding essentials
- Below storage space which perfectly fits book boxes
- 2 year whiteboard surface warranty

EBBTC	Read Write & Store Centre	1580mm x 800mm x 475mm	
EMSAU-D	Aussie Dotted Thirds Magnetic Sheet	750mm x 600mm	NEW



Hang big books



Lockable storage



Magnetic Aussie dotted thirds for handwriting



Flat-packed - self-assembly required
 Assembly service available upon request - not available at all locations.

Coloured Frame Big Book Buddy

Big Book Buddy is a 1200 x 700mm multi-coloured framed whiteboard. Easily solves the problem of showing those hard to hold books. Designed with adults, children and those with a disability in mind. With a multi colour frame, this whiteboard is great for use in Daycare, Kindergartens, Pre-Primary and Primary Schools. Easy to move around the room or to another room as required.

- Locking castor wheels
- Full length built-in shelf for book display

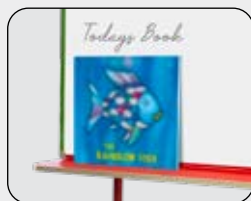

Wide built-in shelf

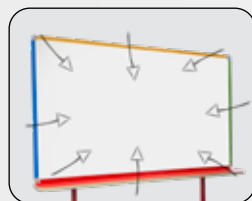

Coloured frame promotes attention in students

CKBBBR	Big Book Buddy
---------------	----------------



BETA

Porcelain Mini Mobile

- 25 Year porcelain surface warranty
- Two sided 600mm x 400mm magnetic porcelain whiteboard
- Quality lockable castor
- Aluminium pen tray on each side



EBO-30 BETA Mini Mobile Whiteboard 1000 x 600 x 680mm



Pen tray both sides



Under storage

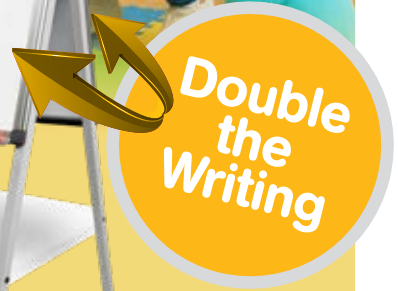

Flat-packed - assembly required

Literacy Lesson

Reading & Display Centre

- A versatile, mobile storage and teaching centre, perfect for small group literacy sessions and organising resources
- Porcelain whiteboard surface: 1000mm (W) x 700mm (H)
Includes a 100mm (W) ledge
- Back storage for protection of books, 2 baskets at the base
- Height is adjustable to four distinct levels, using pop-pins
- Mounted on lockable castors

ELC Reading & Display Centre 1450 x 1000mm

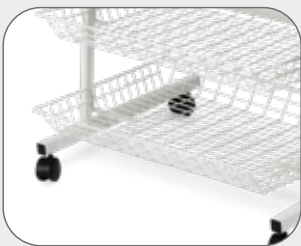

2 Level big book bin



Back storage rack



Flat-packed - assembly required



ALPHA AD1 Porcelain Mobile

- A-shaped design is more stable compared to a traditional mobile whiteboard
- 50mmØ locking castor wheels and satin silver aluminium frame
- Removable Storage Shelf: 915mm (L) x 190mm (W)
- Minimal assembly required, just screw on the wheels, then it's ready for use
- Size: 1800mm (H) x 900mm (W)
- Weight: 28kg

VAPB1890	Alpha AD1	1800 x 900mm
----------	-----------	--------------



Magnetic dry-wipe surface



Removable storage shelf



Fold in flat & store



4 locking castor wheels





Communicate

Room Divider



Double-sided Mobile Communicate Divider Whiteboard/Pinboard

Functional and very versatile double-sided room divider. Sold individually, multiple dividers can be linked together and form any shape. Create any learning space or meeting area required.

- OPTION 1 - double sided magnetic whiteboard
- OPTION 2 - magnetic whiteboard one side & pinnable fabric the other side
- 1800 x 900mm, with large lockable 90mm castors
- 2 flipchart hooks and 150mm magnetic pen tray included
- 2 year whiteboard surface warranty

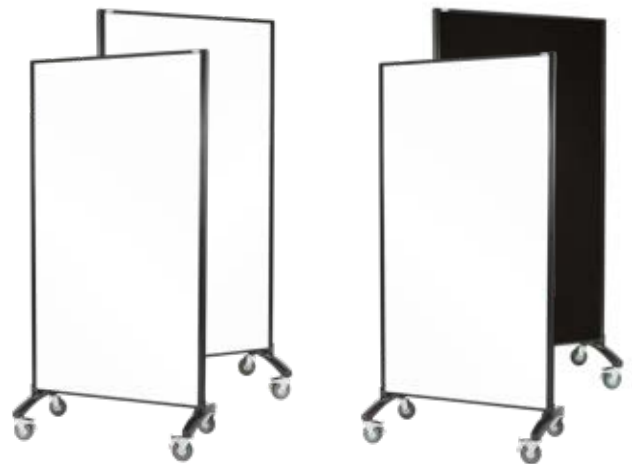

Option 1

Double Whiteboard

Option 2

Whiteboard / Pinboard



Locking Castor Wheels



Leg Connector Kit Option

VRD1890-WW	Option 1: Whiteboard / Whiteboard
VRD1890	Option 2: Whiteboard / Charcoal Pinboard
VRD1890C	Room Divider - Connector Kit



Connect as many as you need for art displays or walkways

Huddle

The Ultimate Mobile



Easy glide locking wheels



Dry wipe magnetic surface



Storage Shelves

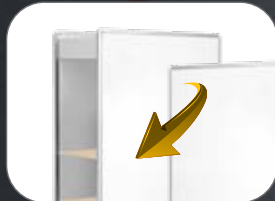

Double-sided Whiteboard



Huddle Double Mobile Storage Whiteboard

- Size: 840mm (W) x 1800mm (H) x 374mm (D)
- Design: Double-sided magnetic whiteboard
- Function: Split into two for shared and adaptable learning spaces
- Storage: 3 adjustable shelves on each end, 10 compartments total
- 2 year whiteboard surface warranty

HUD180	OPTION 1: Huddle
HUD180-EX	OPTION 2: Huddle and 10 Tote Trays
HUD180-SB	OPTION 3: Huddle and 10 Baskets



Option 1
Huddle Whiteboard



Option 2
Huddle Whiteboard with 10 Tote Trays



Option 3
Huddle Whiteboard with 10 Baskets

Student Whiteboards

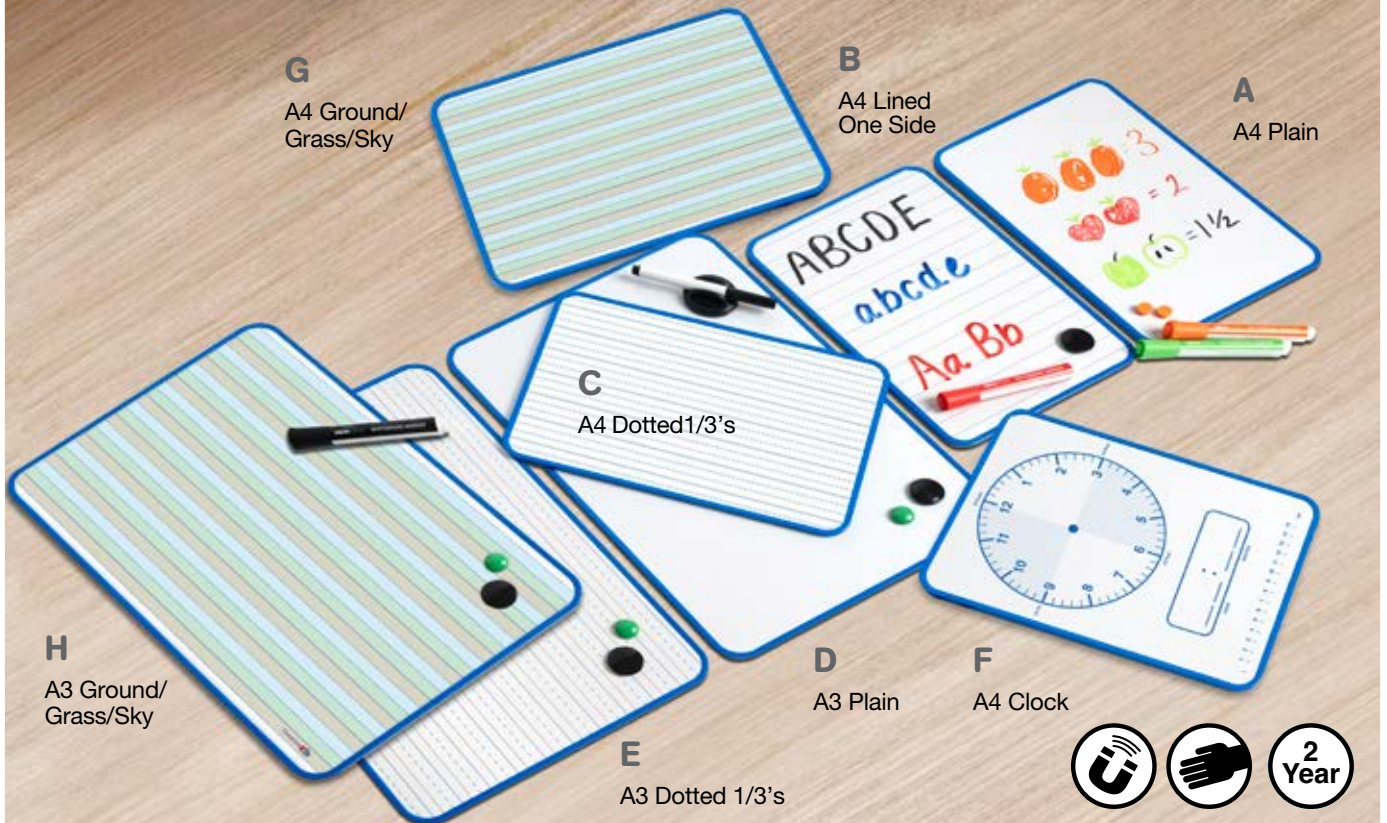

Double-sided & Magnetic Tablet Whiteboards

Enhance classroom participation and learning engagement with our versatile mini whiteboards. These portable, reusable tools are perfect for interactive teaching, enabling students to actively participate and visualize concepts, fostering a collaborative educational environment.

Double-sided, lightweight magnetic whiteboards ideal for agile education. Great for collaborative group and individual focused learning.

- Size: A4 297mm (W) x 210mm (H)
- Size: A3 420mm (W) x 297mm (H)
- Sturdy navy blue moulded frame
- Save paper and allow students to practice skills
- Use any whiteboard markers, wipes clean easily
- 2 year whiteboard surface warranty

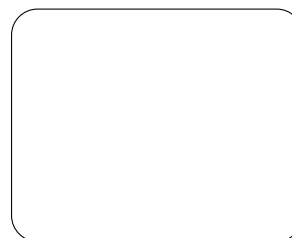

A4 Plain
Double Whiteboard

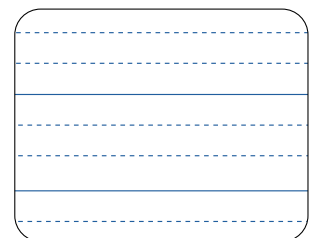

A4 Dotted Thirds One Side
Double Whiteboard

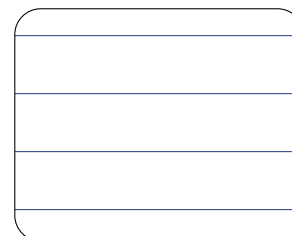

A4 Lined One Side
Double Whiteboard

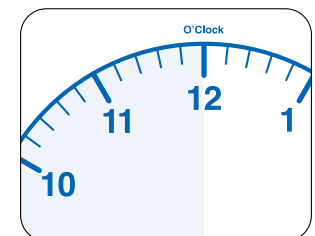

A4 Clock One Side
Double Whiteboard

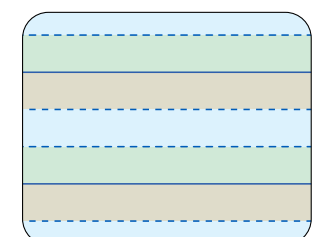

A4 Ground/Grass/Sky One Side
Double Whiteboard

A	EDSWBA4	Double-Sided A4 Mag Whiteboard
B	EDSWBA4-L	Double-Sided A4 Mag Whiteboard - Lined One Side
C	EDSWBA4-D	Double-Sided A4 Mag Whiteboard - Dotted Thirds
D	EDSWBA3	Double-Sided A3 Mag Whiteboard
E	EDSWBA3-D	Double-Sided A3 Mag Whiteboard - Dotted Thirds
F	EDSWBA4-C	Double-Sided A4 Mag Whiteboard - Clock
G	EDSWBA4-GGS	Double-Sided A4 Mag Whiteboard - Ground/Grass/Sky One Side
H	EDSWBA3-GGS	Double-Sided A3 Mag Whiteboard - Ground/Grass/Sky One Side
	EDSWBA4-0006	Double-Sided A4 Mag Whiteboard - Bundle Pack of 25

NEW
NEW
NEW

Student Whiteboard Accessories

Student Magnetic Erasers



- 12 Pack - assorted colours
- Small Size: 50mm x 50mm
- Soft layered foam

VA0024 12 Assorted Erasers

Write N Wipe Black Markers with Eraser Tip



- Student-friendly markers with built-in erasers – save time and clutter
- Quick-dry ink – clean and convenient - clear writing every time
- Each lid contains a magnetic tile so they can stick to any magnetic surface
- Perfect for class sets, group tasks, or everyday use

EWWM-BK10 Markers with Eraser Tip Black Pack of 10

NEW

Marker / Eraser Duo



- Fine point marker, dry eraser
- Magnetic eraser / pen holder

VA0006 Magnetic Marker / Eraser Duo

Write N Wipe Assorted Colour Markers with Eraser Tip



- Boost creativity with colourful markers - easy to use and clean
- Smooth writing, low odour, no mess with Eraser tip – fix mistakes instantly
- Each lid contains a magnetic tile so they can stick to any magnetic surface
- Perfect for classrooms, group learning, and everyday use

EWWM-A5 Markers with Eraser Tip Assorted Colours Pack of 5

NEW

Standard Size Perpetual Year Planner

Perpetual yearly planner magnetic whiteboard. Laminated surface with 2 year warranty. Generally dry wipe, occasional wet wipe is needed. Supplied with:

- Includes: 12 magnetic date strips (1–31) and 10 magnetic public holiday strips
- Includes: 2 fine point erasable markers
- Includes: Magic Wipe microfiber cleaning cloth
- 2 year whiteboard surface warranty

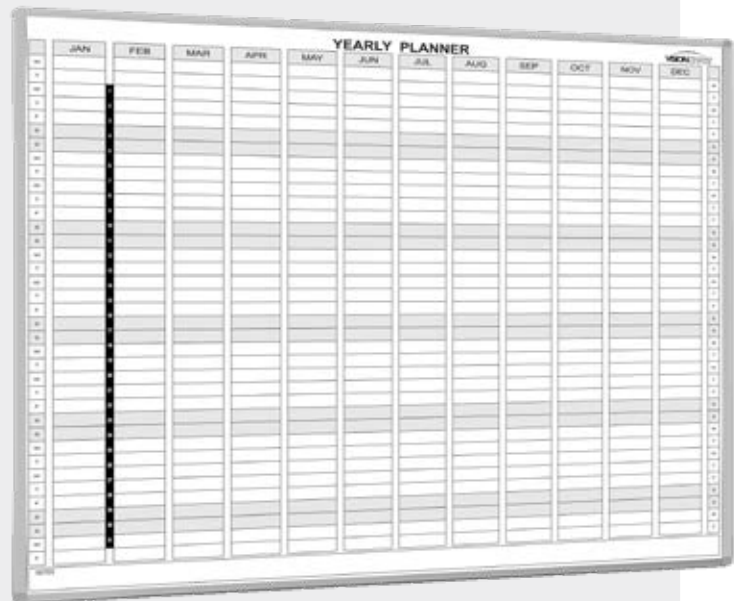

VDP001	1200 x 1200mm	Cell Sizes: 78 x 27mm
VDP002	1500 x 1200mm	Cell Sizes: 99 x 27mm
VDP003	2400 x 1200mm	Cell Sizes: 163 x 27mm

Standard Size Perpetual Month Planner

- Stylish aluminium frame with rounded corners
- Mounting kit supplied for easy installation
- Magnetic surface – use with magnets and markers
- Perpetual monthly planner – reuse every month
- Low maintenance – generally dry wipe, occasional wet wipe needed
- 1200 x 900mm

*Organisation
at a glance*



VMP100	Perpetual Month Planner	Cell Sizes: 160 x 145mm
---------------	-------------------------	-------------------------

Standard Size Term Planners

- Essential for every school – available in 3 sizes
- Layout options: 4 school terms (11 weeks) or single term with daily/weekly intervals
- Laminated graphic surface with permanent lines
- Includes: 2 fine point erasable markers
- Includes: Magic Wipe cleaning cloth
- 2 year whiteboard surface warranty

Get Organized



Week	Monday	Tuesday	Wednesday
1			<i>Day 1 Ter</i>
2			
3		<i>Maths Exam 1</i>	
4			



VDT401	4 Term	1200 x 900mm	Cell Size: 44 x 61mm
VDT402	4 Term	1500 x 1200mm	Cell Size: 55 x 80mm
VDT403	4 Term	2400 x 1200mm	Cell Size: 90 x 81mm
VDT100	Single Term	1200 x 900mm	Cell Size: 201 x 61mm

Standard Size Music Boards

- Permanently ruled with 4 music staves
- Magnetic dry-wipe surface
- Pen tray with red, blue and black markers included
- Mobile music board is one side music board while the other side is a plain porcelain whiteboard

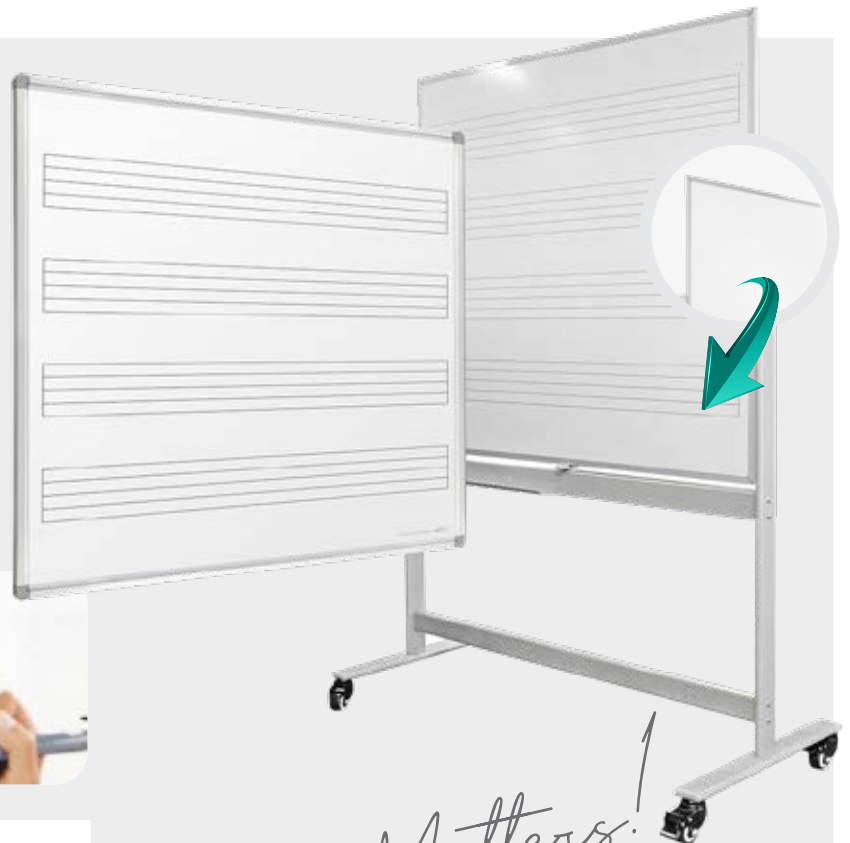

VMB1212	1200 x 1200mm	Wall-mount
VMB1512	1500 x 1200mm	Wall-mount
VMB1812	1800 x 1200mm	Wall-mount
VMB2412	2400 x 1200mm	Wall-mount
VM1212-M	1200 x 1200mm	Mobile Combo
VM1812-M	1800 x 1200mm	Mobile Combo

Music Matters!

NEW

School Planner Whiteboards Your School Logo & Colours



Custom printed school term planners featuring your school's logo and colours, available in two standard sizes using the Visionchart aluminium frame with rounded corners. These magnetic whiteboards are designed with a perpetual layout for easy reuse term after term. Other sizes and formats are available—please contact us with your specific requirements.



School Theme 4 Term
PSP1512-4T 1500 x 1200

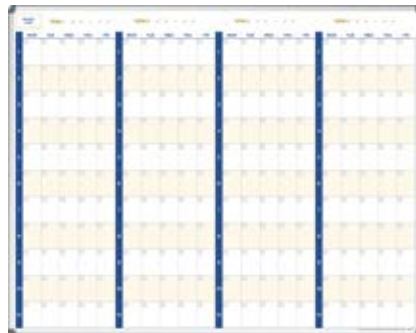

School Theme 4 Term with Dates
PSP1512-4TD 1500 x 1200

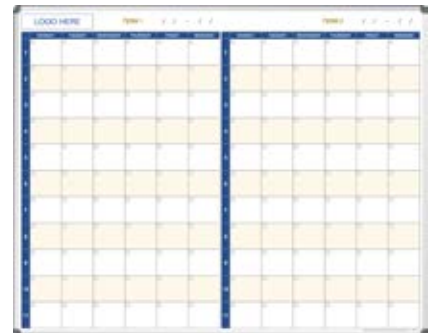

School Theme 2 Term with Dates
PSP1512-2TD 1500 x 1200

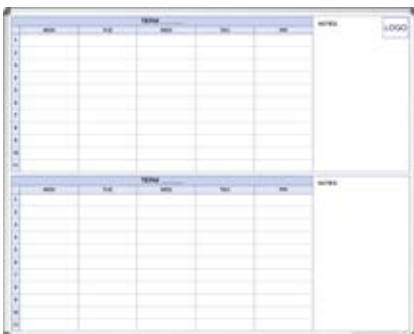

School Theme 2 Term Stacked
PSP1512-2TS 1500 x 1200

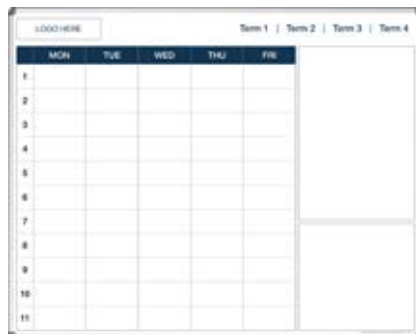

School Theme 1 Term with Sections
PSP1512-1TS 1500 x 1200



School Theme 1 Term with Notes
PSP1512-1TN 1500 x 1200

NEW

Sports Coaching Whiteboards Your Team Logo & Colour



Sports coaching whiteboards personalised with your team or school logo and colours, available in portable handheld or large wall-mounted formats. Ideal for game strategy sessions across a range of sports.

Additional sizes and custom layout options are available—contact us for more information.



AFL Coaches Board
PSB6040AFL 600x400



Basketball Coaches Board
PSB6040BSK 600x400



Netball Coaches Board
PSB6040NET 600x400



Soccer Coaches Whiteboard
PSB1512SOC 1500x1200

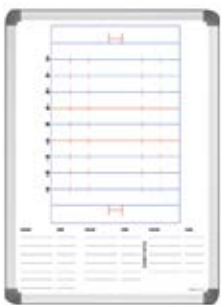

NRL Coaches Board
PSB6040NRL 600x400

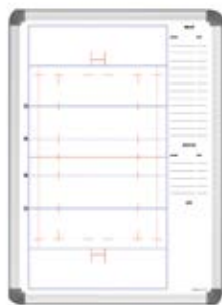

Rugby Union Coaches Board
PSB6040RBU 600x400



Soccer Coaches Board
PSB6040SOC 600x400

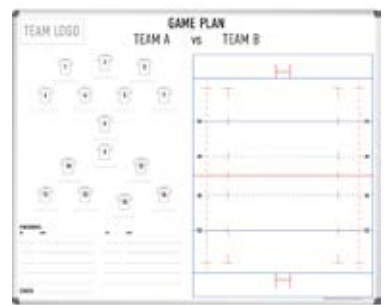

Rugby Union Coaches Whiteboard
PSB1512RBU 1500x1200

PRINTED BOARDS CUSTOM WHITEBOARD & PLANNERS

Classroom Acoustics

Good classroom acoustics make a big difference. When noise bounces around a room, it can make it hard for students to hear, focus, and learn. That's why adding acoustic panels to walls and ceilings helps create calmer, clearer learning environments. Whether it's reading out loud or group work, reducing background noise supports better communication and concentration for everyone in the classroom. Plus, with fun colours and pinnable surfaces, they're as practical as they are creative.



Self-adhesive and easy to install—no tools or trades needed. Wall panels, pinnable and Velcro-friendly surfaces, and desk screens all designed for quick classroom transformations.

Easy Stick Acoustic Wall Panels 2800 x 1200 x 12mm

- Cover a large area instantly - floor to ceiling solution
- Solid colour requires no edging or capping for a perfect finish
- Easy install, just peel and stick to most surfaces*
- Cut to size or around fittings easily with a utility knife
- Manufactured from 60% minimum recycled fibre content
- Acoustic comfort for where we live, work, and learn
- Acoustic Rating NRC 0.45 (noise reduction coefficient)
- Permanent adhesive backing
- Choose from Select colours (lead times may apply)

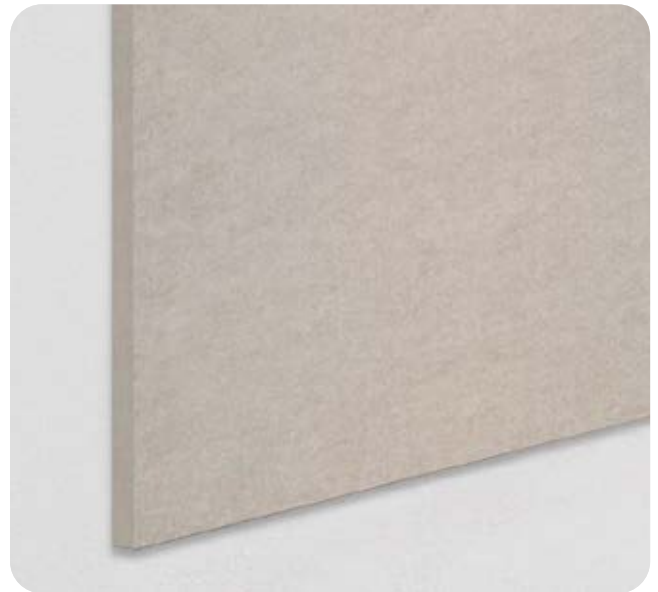
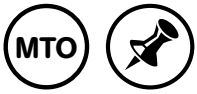

SANA-PS2812-AL55	Almond
SANA-PS2812-AZ05	Azure
SANA-PS2812-BE06	Berry
SANA-PS2812-CA08	Carrot
SANA-PS2812-CE65	Celery
SANA-PS2812-CH01	Charcoal
SANA-PS2812-CU59	Currant
SANA-PS2812-DE09	Denim
SANA-PS2812-FL61	Flamingo
SANA-PS2812-FL64	Flint

SANA-PS2812-GR62	Granite
SANA-PS2812-GR02	Grey
SANA-PS2812-IR10	Iris
SANA-PS2812-IV11	Ivory
SANA-PS2812-KA12	Kale
SANA-PS2812-LI13	Lilac
SANA-PS2812-MA15	Marine
SANA-PS2812-ME03	Metal
SANA-PS2812-MI16	Midnight
SANA-PS2812-OR18	Oregano

SANA-PS2812-PE19	Peach
SANA-PS2812-PE20	Peacock
SANA-PS2812-PE21	Pearl
SANA-PS2812-PE22	Peppercorn
SANA-PS2812-PE23	Periwinkle
SANA-PS2812-PI24	Piano Black
SANA-PS2812-PI25	Pistachio
SANA-PS2812-PL04	Platinum
SANA-PS2812-PO26	Popcorn
SANA-PS2812-QU67	Quartz

SANA-PS2812-SE57	Sea Salt
SANA-PS2812-SE58	Sencha
SANA-PS2812-SH63	Shiraz
SANA-PS2812-SL27	Slate
SANA-PS2812-TH28	Thistle
SANA-PS2812-TU60	Tumeric
SANA-PS2812-UM54	Umber
SANA-PS2812-WA56	Walnut
SANA-PS2812-WA29	Wasabi
SANA-PS2812-WH12	White

Acoustic Pinnable Peel 'n' Stick Tiles

Six Pack Coloured Tiles

- Autex® adhesive-backed tiles – a colourful, practical solution for drab walls
- Perfect for: classrooms, libraries, staff rooms, halls, entranceways
- Pinboard-ready – works with Velcro® hook & loop
- Tile size: 600mm x 600mm
- Pack of 6 tiles – total coverage: 2.16m²
- Acoustic rating: NRC 0.40
- Choose from Autex® colours – lead times may apply



QSTACR	Acros PK6
QSTATL	Atlantis PK6
QSTBAR	Bark PK6
QSTBEE	Beehive PK6
QSTBLA	Blazing Red PK6
QSTCAL	Calypso Blue PK6
QSTCAN	Canyon PK6
QSTCAS	Caspian PK6
QSTCAV	Cavalier PK6
QSTCHI	Chilli Red PK6

QSTELE	Electric Blue PK6
QSTEMP	Empire PK6
QSTFAL	Falling Water PK6
QSTFLA	Flatiron PK6
QSTGHE	Gherkin PK6
QSTGRA	Granny Smith PK6
QSTHER	Herald PK6
QSTHIG	Highland PK6
QSTINK	Ink PK6
QSTJAD	Jade PK6

QSTKOA	Koala PK6
QSTLIM	Lime PK6
QSTMUR	Muralla PK6
QSTMYS	Myst PK6
QSTOCT	Octane PK6
QSTOPE	Opera PK6
QSTPAR	Parthenon PK6
QSTPET	Petronas PK6
QSTPIN	Pinnacle PK6
QSTPOR	Porcelain PK6

QSTSAG	Sage PK6
QSTSAR	Sargazo PK6
QSTSAV	Savoye PK6
QSTSEN	Senado PK6
QSTSIM	Simba PK6
QSTSPE	Spearmint PK6
QSTSTO	Stonewash PK6
QSTTER	Terrace PK6
QSTTRE	Tree House PK6
QSTVIN	Vintage PK6

Easy Stick Tiles Jigsaw Puzzle

Two Colour Shaped Tile Packs

- Peel 'n' Stick Acoustic Tiles – 2 Colours per Pack
- Easy-to-install adhesive-backed tiles for vibrant learning spaces
- Combine with standard 600x600mm tiles for large, unique designs
- Surface: Velcro® receptive & pinnable
- Acoustic: Absorbs up to 40% of noise (NRC 0.40)
- Application: Peel and stick – no tools required
- Colours: Choose from Autex® range (lead times may apply)



QAJ4	SANA Easy Stick Tiles - Jigsaw - 4 Pack
QAJ6	SANA Easy Stick Tiles - Jigsaw - 6 Pack
QAJ8	SANA Easy Stick Tiles - Jigsaw - 8 Pack

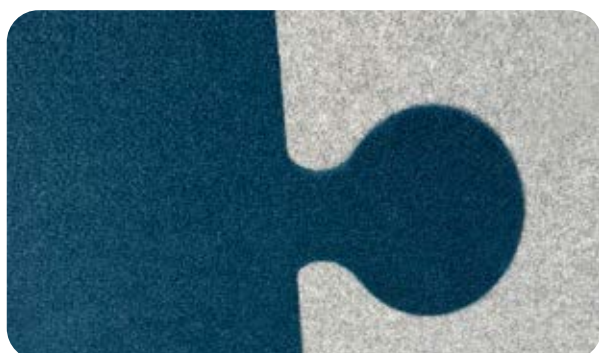

Acoustics & Pinboards Adhesive Panels & Tiles

Acoustic Pinnable Composition

- Composition® Acoustic Wall Covering
- Ideal for: Education, creative, and collaborative spaces
- Material: 100% polyester fibre (PET)
- Size: 1220mm (W) roll, 25m length
- Thickness: 10–12mm
- Acoustic rating: NRC 0.40
- Surface: Pinnable, hook-and-loop receptive, self-healing
- Finish: Rich, solid colour, soft velvety texture
- Fire rating: Group 1, (SMOGRArc) <math><100\text{m}^2/\text{s}^2</math>
- Installation: Direct fix



Call for a quote and Installation service.
See p.47 to see how this can transform your space

Peel 'n' Stick Tiles, Jigsaw Tiles, Composition® & Vertiface® Colour Range

Sargazo	Vintage	Chilli	Blazing Red	Simba	Beehive	Senado	Canyon
Electric Blue	Octane	Muralla	Ink	Calypso	Stonewash	Atlantis	Falling Water
Caspian	Pinnacle	Porcelain	Myst	Herald	Empire	Koala	Petronas
Tree House	Gherkin	Sage	Spearmint	Jade	Granny Smith	Lime	Acros
Highland	Terrace	Cavalier	Opera	Savoie	Parthenon	Flatiron	

subject to change - check with our team for colour availability

Easy Stick Tiles Hexagon

Six Pack Adhesive Tiles

- Hexagon Acoustic Tiles
- Create unique modular acoustic walls with easy side-by-side mounting
- Application: Peel and stick – no tools required
- Surface: Pinnable and versatile
- Acoustic: Absorbs up to 45% of noise (NRC 0.45)

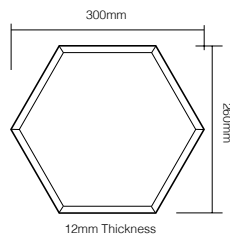

Shadow	Moonlight	Frost	Mushroom

SANA-HEX-MIX	SANA Easy Stick Tiles - Hexagon - Mix Colour Pack 2 Each: Shadow, Moonlight, Frost
SANA-HEX-ML	SANA Easy Stick Tiles - Hexagon - Moonlight
SANA-HEX-SD	SANA Easy Stick Tiles - Hexagon - Shadow
SANA-HEX-FR	SANA Easy Stick Tiles - Hexagon - Frost
SANA-HEX-MU	SANA Easy Stick Tiles - Hexagon - Mushroom

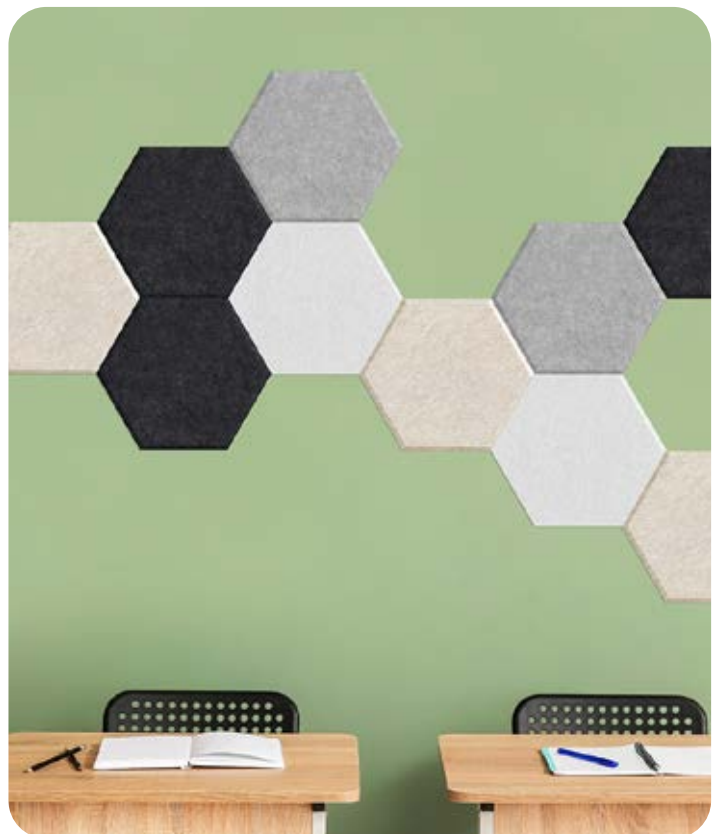

NEW

School Office Acoustics Altitude Desk Screen



Designed for busy, often noisy school environments, this acoustic desk screen helps reduce distractions, improve privacy, and create a calm space to focus.

It easily attaches to any standard desk using two secure clamps—no tools required. Available in four popular colours and a range of widths to suit most desks.



Width	Height 600mm	Height 800mm	Clamps White	Clamps Black
1200mm	DS12-SD-1260	DS12-SD-1280	DCPW-SANA	DCPB-SANA
1500mm	DS12-SD-1560	DS12-SD-1580		
1800mm	DS12-SD-1860	DS12-SD-1880		
2400mm	DS12-SD-2460	DS12-SD-2480		

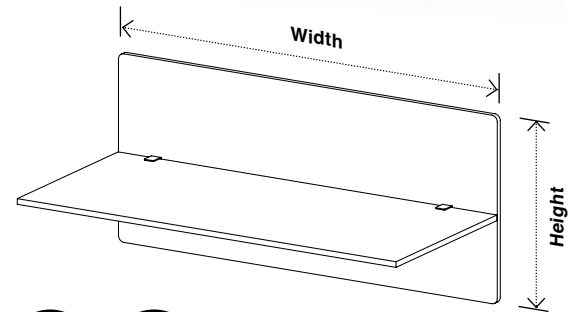

COLOUR

Shadow Moonlight Mushroom Frost



CLAMPS (sold separately)

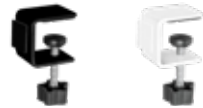

Matte black or matte white



NEW

Office or Classroom Slide on Desk Screen



Ideal for creating instant privacy during exams or quiet study, this slide-on acoustic desk screen helps minimise noise and visual distractions.

Designed to fit snugly onto any 25mm desk top—no tools or clamps required—it offers the same sound-absorbing benefits with a simple, portable setup. Available in a range of colours and sizes to suit most desks.



Height:	420mm above desk	
Depth on desk:	680mm	
Style	Incline	DS24-SL-INC8042
	Arc	DS24-SL-ARC8042
	Altitude	DS24-SL-ALT8042



COLOUR

Shadow Moonlight Mushroom Frost

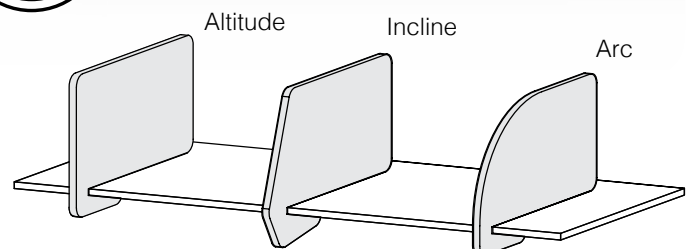

NEW

Office or Classroom Slide on Surround Desk Screen



This slide-on surround desk screen creates a quiet, enclosed workspace—perfect for focused tasks, one-on-one support, or added privacy in shared areas.

It provides the same acoustic benefits, reducing ambient noise while offering greater visual separation. It simply slides onto any 25mm desktop—no tools required.



Width on desk		940mm
Height above desk		420mm
Depth on desk		680mm
Style	Incline	DS24-SU-INC9442
	Arc	DS24-SU-ARC9442
	Altitude	DS24-SU-ALT9442

COLOUR

Shadow Moonlight Mushroom Frost

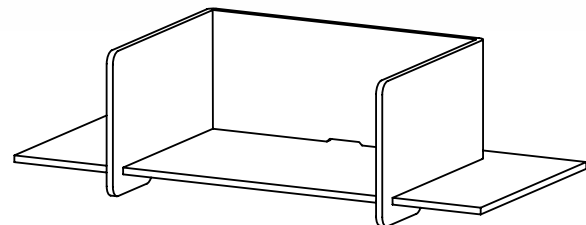

NEW

Office or Classroom Drop in Acoustic Ceiling Tile



- Drop-In Ceiling Tiles – Pack of 8 (Single Colour)
- For: Office or classroom ceilings
- Material: 12mm Acoustic PET panels (60% recycled PET)
- Size: 1195mm x 595mm x 12mm (standard ceiling tile size)
- Acoustic: Absorbs up to 40% of noise (NRC 0.40)
- Colour: Choose a single colour per pack

SANA-CEL-ML	SANA Ceiling Tile - Moonlight
SANA-CEL-MR	SANA Ceiling Tile - Mushroom
SANA-CEL-SD	SANA Ceiling Tile - Shadow
SANA-CEL-FR	SANA Ceiling Tile - Frost

COLOUR

Shadow Moonlight Mushroom Frost

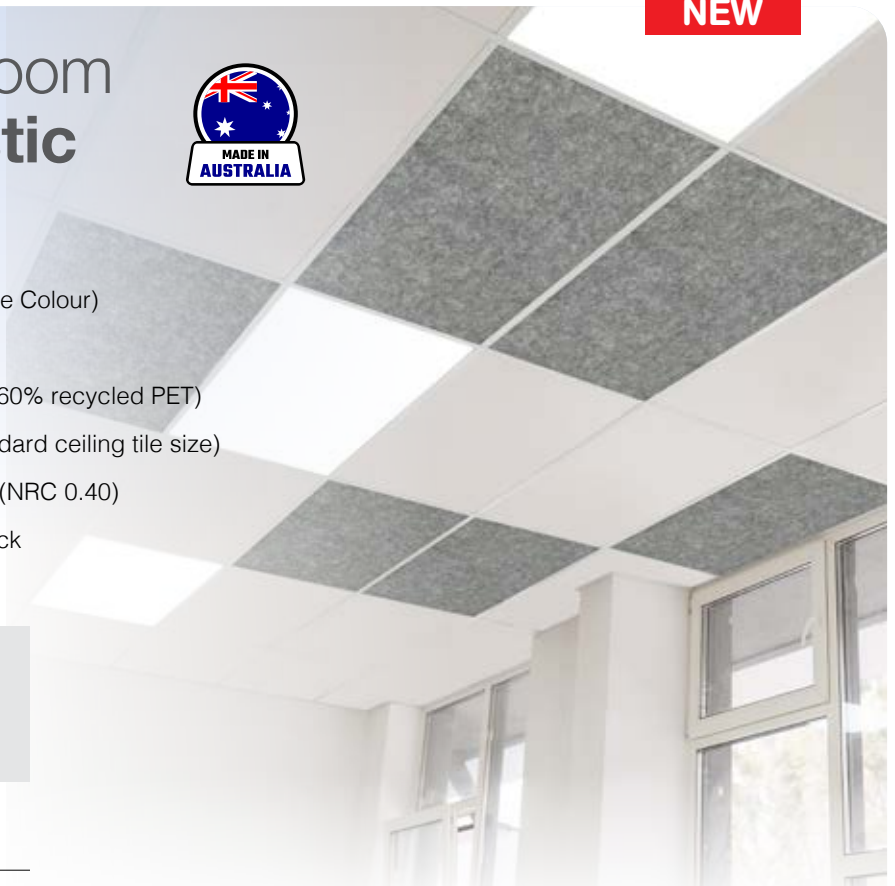

Organise, Display, Inspire

Wall-mounted Pinboards



The perfect tool for organising and showcasing student work in classrooms. Versatile and durable, these boards provide a creative space for students and educators to display projects, notes, and visual aids.

Velcro Receptive® Wrapped Pinboards

- Popular design: No aluminium frame, clean edges
- Material: Autex® Vertiface over 12mm Bioboard™ (eco-friendly)
- Sizes: 9 standard options + custom sizes up to 2400mm x 1200mm (MTO lead times apply)
- Versatile: Use as a single board or create a colourful feature wall
- Fixing kit included: suitable for Gyprock or brick with screw caps
- Colour options: Choose from Autex® Vertiface range (MTO lead times apply)



UFF9060	900x600	UFF1512	1500x1200
UFF9090	900x900	UFF1890	1800x900
UFF1290	1200x900	UFF1812	1800x1200
UFF1212	1200x1200	UFF2412	2400x1200
UFF1590	1500x900		



Velcro Receptive® Framed Pinboards

- Low-Maintenance Pinnable Pinboards
- Ideal for: Libraries, classrooms, staff rooms, halls and entrances
- Material: Autex® Vertiface
- Finish: Aluminium frame with wall fixture included
- Made in Australia
- Surface: Pinboard, Velcro® hook-and-loop ready
- Colour options: Autex® Vertiface (MTO lead times apply)



AVP9060	900x600	AVP1512	1500x1200
AVP9090	900x900	AVP1890	1800x900
AVP1290	1200x900	AVP1812	1800x1200
AVP1212	1200x1200	AVP2412	2400x1200
AVP1590	1500x900	AVP3012	3000x1200



Sold individually

Modulo Mobile Velcro® Receptive



- Double-Sided Pinnable Screens
- Surface: Autex® Vertiface fabric – stylish, Velcro® friendly (*MTO lead times apply)
- Low-profile 3mm edge – mount side-by-side for seamless communication walls
- Frame: Tough powder-coated finish
- Mobility: Durable locking castors
- Size overall: 1895mm (H) x 1085mm (W) x 50mm (D)
- Pinboard area: 1660mm (H) x 1020mm (W) x 50mm (D)



MDP1810 Modulo Mobile Autex Vertiface

* Specify Autex Vertiface fabric colour when ordering - see page 33

Stock item:

MDP1810A-1	Modulo Mobile Vertiface Lime
MDP1810A-2	Modulo Mobile Vertiface Opera
MDP1810A-3	Modulo Mobile Vertiface Koala
MDP1810A-4	Modulo Mobile Vertiface Blue

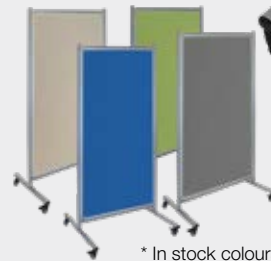

* In stock colours

Library Bay End Panels Velcro® Receptive



- Pinnable and Velcro® receptive surface
- Lightweight design – easily attaches to library shelf ends
- Options: Static or mobile leg design
- Thickness: Approximately 50mm
- Colours: Large range available
- Custom sizes: Made to order



VEPP1200	680 x 1225 x 50mm
VEPP1500	680 x 1525 x 50mm
VEPP1800	680 x 1825 x 50mm

Lightweight Divider Velcro® Receptive

- Designed for: Classrooms and libraries
- Ultra-lightweight – easy to move by adults and children
- Surface: Pinnable and Velcro® receptive
- Thickness: Approximately 50mm
- Assembly: Includes 2 feet that slide into position
- Flexible setup: Fit vertically or horizontally
- Colours: Wide range available
- Custom sizes: Made to order



Mobile Leg Divider

VLWSM0912	1190x900mm
VLWSM1212	1190x1190mm
VLWSM1512	1500x1190mm
VLWSM1812	1800x1190mm

Mobile Leg Divider

VLWSM0915	1500x900mm
VLWSM1215	1500x1190mm
VLWSM0918	1800x900mm
VLWSM1218	1800x1190mm

Static Leg Divider

VLWS0912	1190x900mm
VLWS1212	1190x1190mm
VLWS1512	1500x1190mm
VLWS1812	1800x1190mm

Static Leg Divider

VLWS0915	1500x900mm
VLWS1215	1500x1190mm
VLWS0918	1800x900mm
VLWS1218	1800x1190mm

Something to notice?

Notice Display Solutions



Be Noticed Notice Case Hinged Polycarbonate Door

- Available in silver frame finish with grey pinnable fabric internal
- Suitable for indoor use or under awning use, self fitting lock/s and key
- Hinged Doors - 3mm Strong Polycarbonate - 48mm internal depth

BN-HDC-1290SL	Hinged Door, Grey Felt	2 Door Silver	1220x915mm
BN-HDC-1890SL	Hinged Door, Grey Felt	3 Door Silver	1800x915mm
BN-HDC-1812SL	Hinged Door, Grey Felt	3 Door Silver	1800x1200mm
BN-HDC-1812BL	Hinged Door, Grey Felt	3 Door Black	1800x1200mm



Be Noticed Notice Case Sliding Glass Door

- Available in silver or black frame finish
- Cork or grey pinnable fabric internal
- Suitable for indoor use or under awning use, self fitting lock/s and key
- Glass doors - 3mm Safety Glass - 24mm internal depth
- Hinged Doors - 3mm Strong Polycarbonate - 48mm internal depth

BN-SGC-1290SL	Sliding Door, Grey Felt	2 Door Silver	1220x915mm
BN-SGC-1590SL	Sliding Door, Grey Felt	2 Door Silver	1525x915mm
BN-SGC-1812SL	Sliding Door, Grey Felt	2 Door Silver	1800x1200mm
BN-SGC-1290SC	Sliding Door, Cork	2 Door Silver	1220x915mm
BN-SGC-1590BC	Sliding Door, Cork	2 Door Black	1525x915mm



TX Notice Case (external or internal use)



- Water-resistant design with internal rubber seal
- Lockable – includes 2 keys for security
- Clear Perspex window in a durable aluminium frame
- Depth: 50mm from wall

TX6003	590 x 760mm	4 A4's	Single door, single lock
TX6002	590 x 1080mm	6 A4's	Single door, single lock
TX6001	820 x 1080mm	9 A4's	Single door, single lock
TX6000	1050 x 1080mm	12 A4's	Single door, double lock
TX1390	1350 x 980mm	12 A4's	Double door, double lock

NEO Notice Case (internal use)



- Dry-erase magnetic whiteboard surface
- Lockable and with concealed wall fixings, 33mm depth from wall
- Includes 6 x magnets
- 2 year surface warranty

TXN6045	Single Lock	600 x 450mm
TXN9060	Single Lock	900 x 600mm
TXN1290	Double Lock	1200 x 900mm

Poster Snap Frame



- 25mm alloy frame, with rounded light grey moulded corners
- Quick and easy changing of printed information
- Available in sizes to fit A4, A3, A2 or A1 posters
- Glare free PVC clear front cover lenses

VQ0004	A4
VQ0003	A3
VQ0002	A2
VQ0001	A1

A4 Sign Holder, Adhesive Back



- Clear display with silver frame and magnet snap closure
- Peel off, re-stick design – reusable multiple times
- Size: 239mm x 325mm
- Display orientation: Portrait or landscape

NEW

VRF004	A4 Adhesive Sign Display Silver Frame
---------------	---------------------------------------

Love Your Board

with Premium Starter Kits



Whiteboard Starter Kit
VA800-W

Premium Starter Kits for Glassboards™ or Whiteboards are perfect for Schools! Each starter kit offers Premium Dry Erase Markers, Strong Magnetic Eraser, Black Microfibre Cloth and Board Cleaning Spray.

Whiteboard Starter Kit



- Includes: 8x Dry Erase Chisel Markers
- Strong Magnetic Eraser
- Microfibre Cloth + 237ml Board Cleaning Spray

VA800-W Premium Whiteboard Starter Kit

Glassboard Starter Kit



- Includes: 6x Dry Erase Bullet Markers
- Strong Magnetic Eraser
- Microfibre Cloth + 237ml Board Cleaning Spray
- Bonus: Magnetic Pen Cup

VA800-G Premium Glassboard Starter Kit

Magnetic Pen Cup



- Bevelled shape – maximises storage space
- Strong magnet backing – ideal for Glassboards

VA804 Strong Magnetic Pen Cup

Glass Markers



- Bullet tip for precision writing
- 6-marker pack – Black, Blue, Purple, Green, Orange, Red

VA802 Premium Glassboard Markers Pack

Whiteboard Markers



- Chisel tip for varied writing thickness
- 8-marker pack – 2x Black, Blue, 1x Purple, Green, Orange, Red

VA803 Premium Whiteboard Markers Pack

Magnetic Eraser



- Smooth ergonomic shape for comfortable use
- Strong magnetic backing – ideal for Glassboards

VA805 Strong Magnetic Eraser

Eraser Pads 5 Pack



- 5-pack of eraser pads (VA805)
- Velcro® removable for easy replacement

VA806 Premium Eraser Pads Pack

Board Cleaning Spray



- 237ml board cleaning spray – suitable for Whiteboards and Glassboards
- Pump nozzle for easy application

VA801 237ml Board Cleaning Spray

Microfibre Cloth



- Black microfibre cloth
- Ideal for: Glassboards and Whiteboards
- Includes: Magnetic corner for easy storage

VA807 Black Microfibre Cloth

Essential Accessories

Writing Board Essentials

Magnetic Eraser



115mm x 60mm x 20 mm

VA0002 Soft Magnetic Foam Eraser

Lining & Magnetic Tape



VA0021 Magnetic Tape Dispenser 19mm x 3m

VA0007 Whiteboard Lining Tape 1.5mm x 13m

VA0008 Whiteboard Lining Tape 3mm x 13m

10 Pack Microfibre Cloths



VA0011-RED Red 400mm x 400mm Pack of 10

VA0011-BLU Blue 400mm x 400mm Pack of 10

VA0011-GRN Green 400mm x 400mm Pack of 10

VA0011-YEL Yellow 400mm x 400mm Pack of 10

Magnetic Strips



10mm x 300mm
13mm x 300mm
19mm x 300mm
25mm x 300mm

MAGNETIC STRIPS

300mm x 2	10mm	13mm	19mm	25mm
Black	VWMS10BK	VWMS13BK	VWMS19BK	VWMS25BK
Blue	VWMS10BL	VWMS13BL	VWMS19BL	VWMS25BL
Green	VWMS10G	VWMS13G	VWMS19G	VWMS25G
Orange	VWMS10O	VWMS13O	VWMS19O	VWMS25O
Red	VWMS10R	VWMS13R	VWMS19R	VWMS25R
White	VWMS10W	VWMS13W	VWMS19W	VWMS25W
Yellow	VWMS10Y	VWMS13Y	VWMS19Y	VWMS25Y

Magnet Buttons



13mm
20mm
30mm
40mm

Black Blue Green Yellow Orange Red White

MAGNETIC BUTTONS

	13mm x 16	20mm x 10	30mm x 8	40mm x 4
Black	VWMAG15BK	VWMAG20BK	VWMAG20BK	VWMAG40BK
Blue	VWMAG15BL	VWMAG20BL	VWMAG20BL	VWMAG40BL
Green	VWMAG15G	VWMAG20G	VWMAG20G	VWMAG40G
Orange	VWMAG15O	VWMAG20O	VWMAG20O	VWMAG40O
Red	VWMAG15R	VWMAG20R	VWMAG20R	VWMAG40R
White	VWMAG15W	VWMAG20W	VWMAG20W	VWMAG40W
Yellow	VWMAG15Y	VWMAG20Y	VWMAG20Y	VWMAG40Y

Magnetic Sheets



A4 Size
A3 Size
300mm x 100mm

MAGNETIC SHEETS

	300x100mm	297x210mm	420x297mm
Black	VWMSBK	VWMSA4BK	VWMSA3BK
Blue	VWMSBL	VWMSA4BL	VWMSA3BL
Green	VWMSG	VWMSA4G	VWMSA3G
Orange	VWMSO	VWMSA4O	VWMSA3O
Red	VWMSR	VWMSA4R	VWMSA3R
White	VWMSW	VWMSA4W	VWMSA3W
Yellow	VWMSY	VWMSA4Y	VWMSA3Y

AIRO1200 Height Adjustable Teachers Desk

- No power, cables or electric plug-in needed!
- Height adjustable from 700mm - 1130mm



'Shark Nose' Desk Edge



Rear Wheel Mobile Legs



Air Pressure Lift Handle



Scan QR to watch



AIR012-S	1200mm Legs/Mechanism only. NO TOP included.
AIR012-T	White melamine top to fit 1200mm legs. NO LEGS included.



Lectern

- Professional, stylish black powder coated steel body
- Black melamine shelves for a sleek look
- Non-perforated top section – add your title or logo signage
- Flat pack design – easy self-assembly
- BONUS: A3 clear magnetic signage sleeve
+ flexi clip-on battery-powered LED light
- Overall Size: 1200mm (H) x 445mm (W) x 450mm (D)
- Top shelf: 600mm x 400mm, Middle shelf: 550mm x 260mm



4x locking castors



Second shelf for storage



VL0001	Black Lectern
--------	---------------

- Also see page 13 for Height Adjustable Lectern /Desk

Before



After

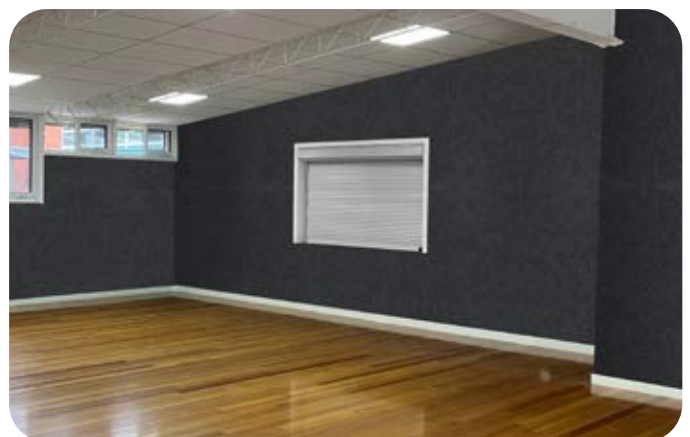
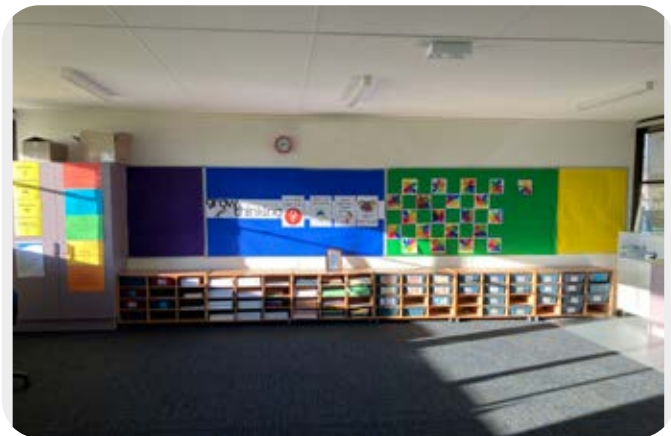

Let Us Transform Your School & Maximise your Students Potential

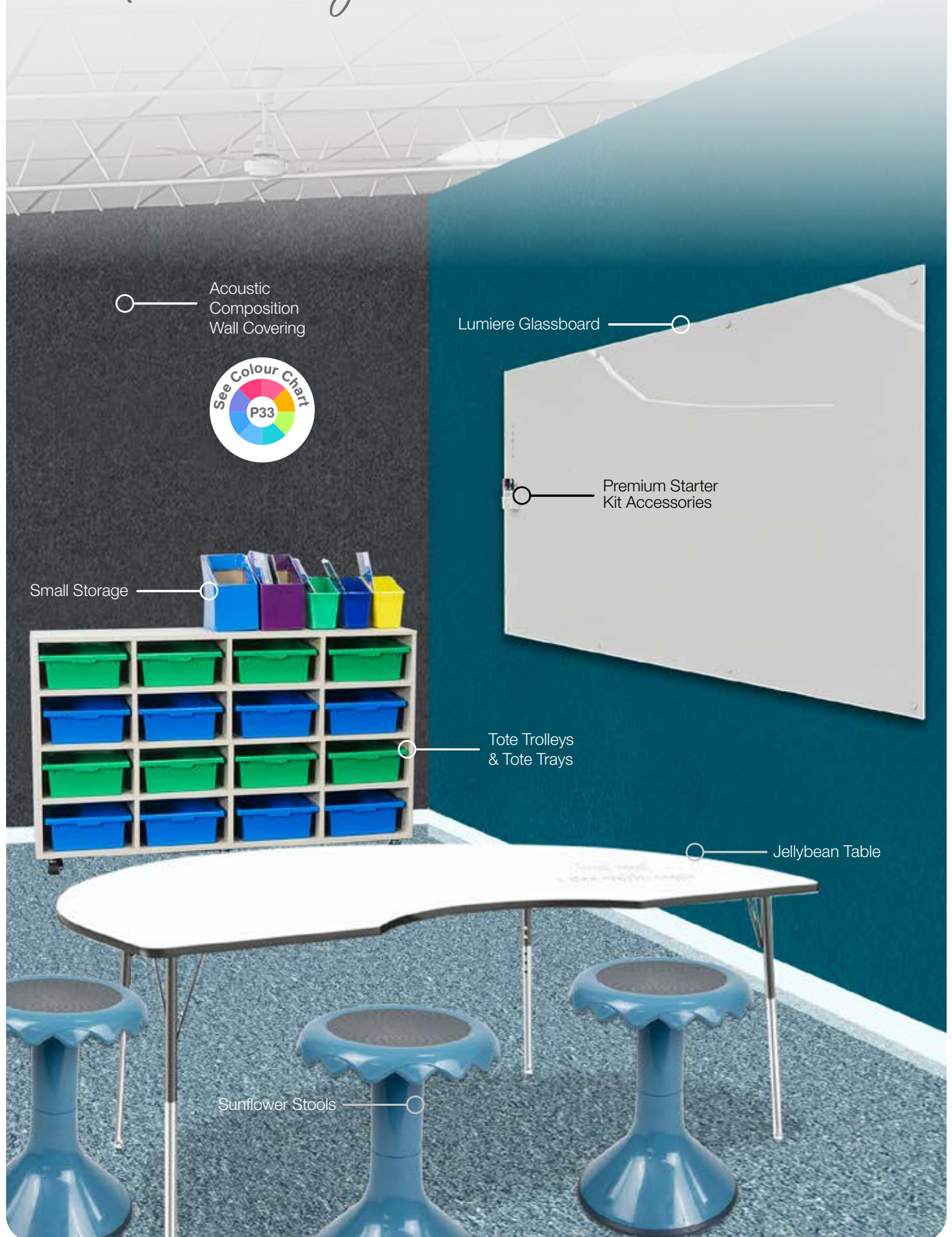

Acoustic Composition Wall Covering



Lumiere Glassboard



Premium Starter Kit Accessories

Small Storage



Tote Trolleys & Tote Trays

Jellybean Table



Sunflower Stools

Sensory Calming Classroom Solutions

Sensory Tent Light-controlled sensory environment

- Two observation windows with ties for visibility
- Double-skin nylon construction blocks light
- Pvc frame, storage bag, and connectors included
- Size: 1500mm x 1500mm x 1500mm
- Suitable for ages 3+



ETENT-L

Sensory Tent Large

NEW



NEW

Supporting Sensory Needs in the Classroom

Classrooms can be busy, bright, and sometimes overwhelming — especially for students with autism, ADHD, or sensory processing differences. That's why more Australian educators are turning to tools like sensory tents to support student wellbeing.

A sensory tent offers a quiet, light-controlled space where students can step away, reset, and regulate their emotions. It's a simple yet powerful addition to any learning environment, helping reduce anxiety and improve focus once students return to class.

By providing these kinds of sensory supports, schools can create more inclusive classrooms that recognise and respond to the diverse needs of their students. As awareness grows around sensory-friendly practices, the sensory tent is becoming an important resource for teachers across all year levels.



Available From:

GIANT
OFFICE FURNITURE

158 Victoria Street, North Geelong
Phone: (03) 52723280
www.giantofficefurniture.com.au